



CATALOG 2025



One Fence, Zero Regrets



Welcome to Greenwood Fence

Step into a world where design meets durability - welcome to Greenwood Fence's 2025 Catalog. As a beacon of innovation since 2019, we're excited to guide you through our curated collection of state-of-the-art composite fencing solutions. Our catalog is more than just a showcase of products; it's an invitation to transform spaces with elegance and strength. Each page unfolds our commitment to sustainability, quality, and the kind of customer experience that turns first-time inquiries into lasting partnerships. Dive in and discover the perfect blend of style, security, and sustainability for your next project.





A Fence That Keeps On Giving

What is a Greenwood Fence?

Greenwood Fence presents a durable composite fencing system combining wood plastic composite boards with stylish aluminum posts and rails. This elegant yet functional solution enhances any outdoor setting. Our Advanced Series boards are sustainably made from recycled materials, offering high density and durability, with a protective shield for longevity and low maintenance. Our commitment lies in innovative design, exceptional customer support, and ensuring our clients receive enduring value and quality that defines our brand.

FOLLOW US

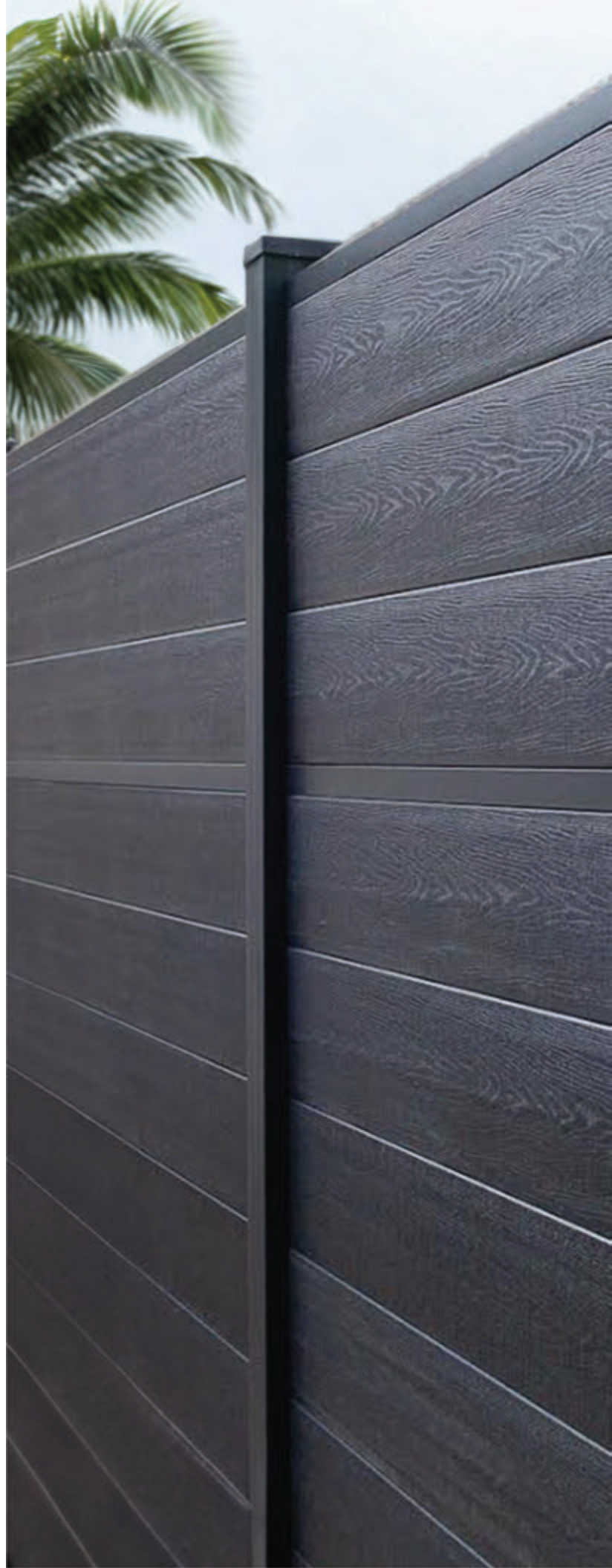

CLASSIC PRIVACY



>110mph
Wind loading



Warranty



Eco-friendly

CLASSIC DELUXE PRIVACY



Low maintenance



Waterproof



Anti-UV

DELUXE SEMI PRIVACY



HORIZONTAL PICKET



DELUXE TRELLIS



Wind loading



Warranty



Eco-friendly

CLASSIC TRELLIS



Low maintenance



Waterproof



Anti-UV

LATTICE SEMI PRIVACY



MODERN PRIVACY



CLASSIC SEMI PRIVACY



Wind loading



Warranty



Eco-friendly

ELITE PRIVACY



Low maintenance



Waterproof



Anti-UV

ELITE DELUXE PRIVACY



ALUMINUM EUROFENCE



FEATURES



**CREATIVITY
WITH
COMPOSITE
FENCING**



A FENCE FOR EVERY VISION:

EMBRACE THE VERSATILITY OF A CUSTOMIZABLE
GREENWOOD FENCE

PARTS



MODULAR FENCE ELEMENTS

Capped Composite - Easy Install

Our sleek modular fencing system, featuring polymer-capped composite boards, offers rapid and straightforward installation while ensuring robust stability. The system's posts and tongue and groove interlocking covers are crafted from sleek aluminum, providing a durable and elegant finish. This design allows for creative customization, accommodating a range of privacy preferences with its innovative materials.



Eco-friendly



Low maintenance



Waterproof



Anti-UV

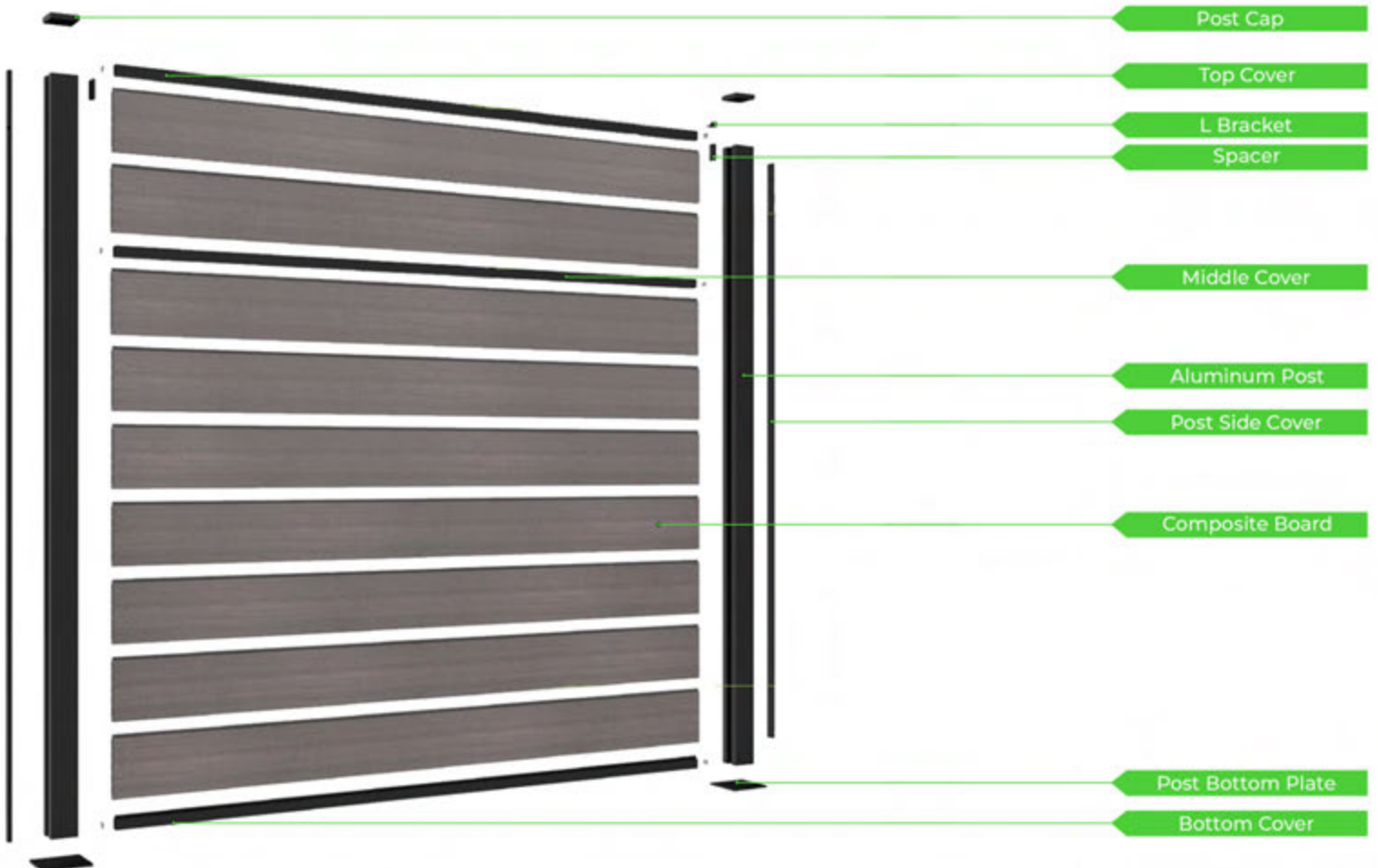

SWIVEL KIT

ADJUSTABLE ANGLE POST

Different Angles, Different Applications

Now with these new aluminum parts, our fence system can be adjusted to very specific angles to accomodate many requirements of different applications.

An axis is inserted into the slot of the post, and the pivot slides over it. The pivot will receive the fence board like a normal line post.



GWF513A5KB

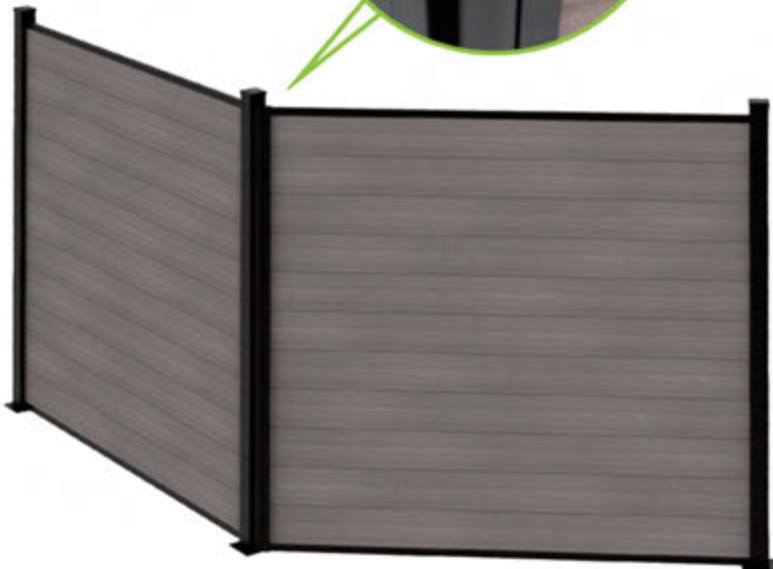
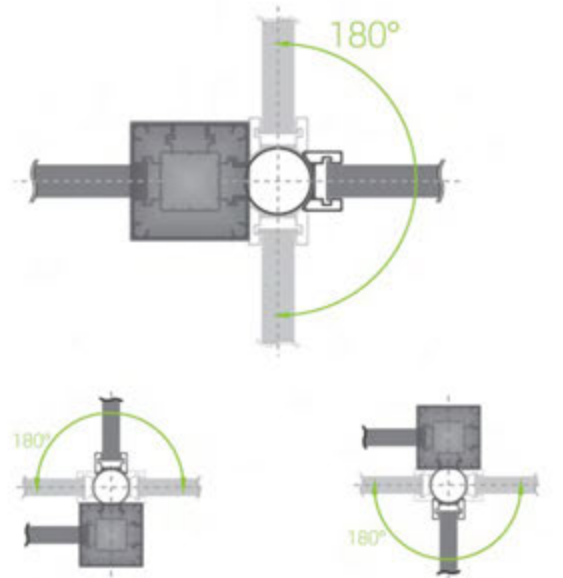

GATES

**Elevate your Space with
Elegance and Strength**

Innovative Aluminum and
Composite Gate Solutions
for the Modern World



Available now at
greenwoodfence.com



GATES

Introducing the GWF Gate Series: Where Elegance Meets Innovation

Crafted for sophistication and designed to last, the GWF Gate Series sets the standard for modern entry solutions. Our gates offer a harmonious blend of durability and low maintenance, ensuring they stand the test of time while maintaining their pristine appearance.

Sleek Design

Each 4-foot-wide gate frame is engineered to accommodate composite or aluminum tongue and groove interlocking boards, ensuring a sleek, coherent look. The seamless frame design conceals hardware and eliminates weld marks, providing a flawless finish that complements any property.

Durability and Quality

Constructed from robust 6063 T6 aluminum alloy, our gates are not just strong but also lightweight. The Qualicoat Certified powder coating process ensures a uniform, durable matte black finish that resists the elements and daily wear. Our commitment to quality means your gate will maintain its integrity and appearance for years to come.

Colorful Customization

Choose from five distinctive colors for board infills to match your style or branding. The full privacy design provides complete seclusion, while the flexible structure allows for semi-privacy customizations to suit your aesthetic and functional preferences.

Optimized Functionality

The 6-foot single and 12-foot double swing gates echo the design principles of the 4-foot model but are exclusively fitted with sleek aluminum boards. This choice not only enhances the visual appeal but also optimizes functionality by maintaining a lighter load, ensuring smooth operation every time.



GATE POST

THE “NO DIG” WALL MOUNT 2” x 3” GATE POST

Expertly Engineered for Distinctive Spaces

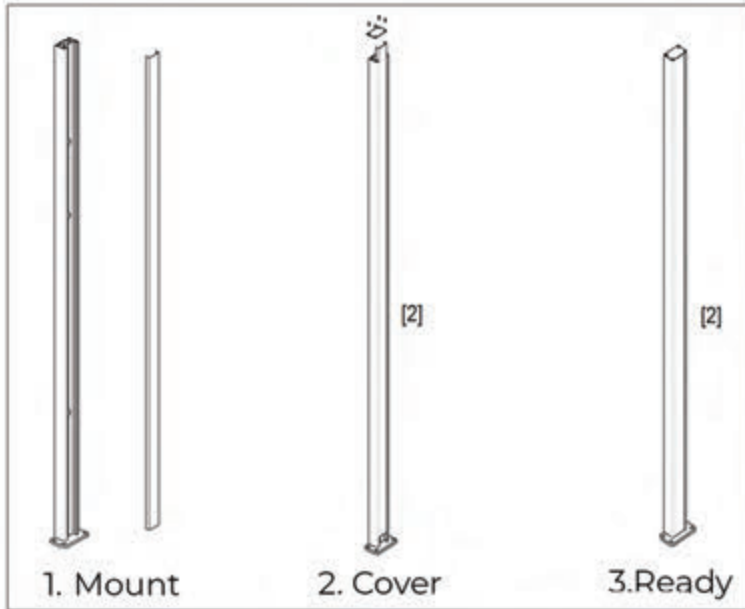

Engineered for convenience and durability, the 2”x3” GWF Wall Mount Gate Post integrates seamlessly with our GWF gate series. Its sleek aluminum profile saves space and mounts directly to brick or concrete - **no digging required** -ensuring a clean, unified look that blends perfectly with your gate and surroundings.

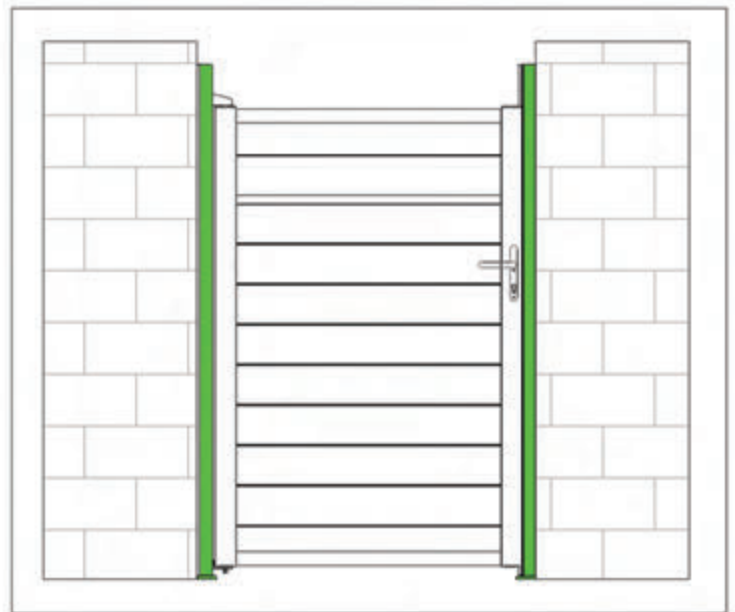

- **Space-Saving Slim Design:** Fits narrow openings while maintaining a sturdy, reliable support.
- **No-Dig Installation:** Mounts directly on masonry or concrete surfaces for a quicker, cleaner install.
- **Seamless Aesthetic:** Sleek aluminum post is designed to match the modern lines of our GWF gate.
- **Engineered Strength:** Built to handle everyday use, weather, and gate operations without sacrificing style.

GATE PARTS

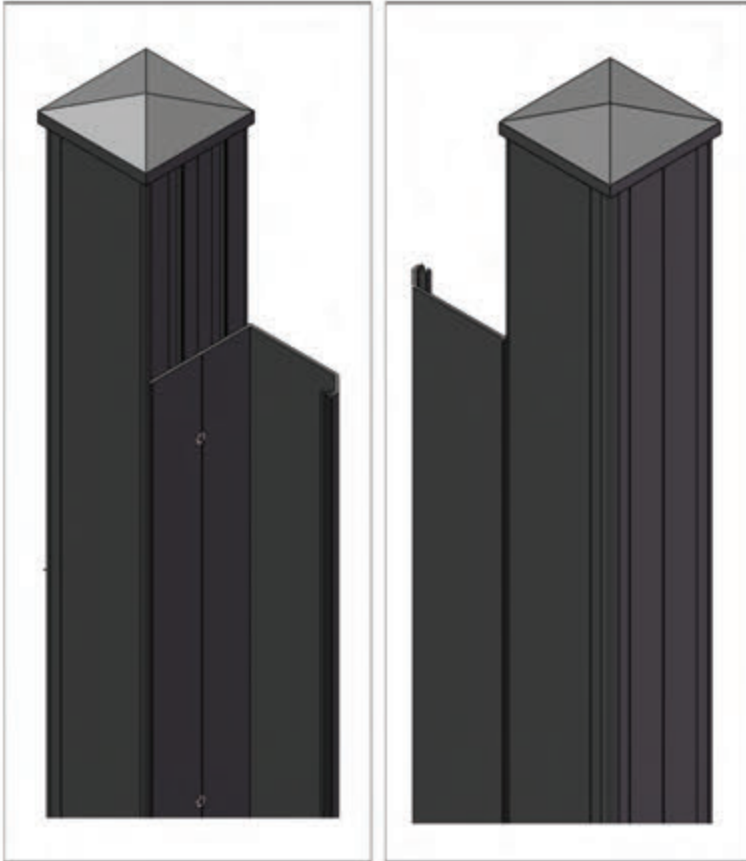
THE "GAPLESS GATE" GWF
GAP CLOSERWhere Entryways Become
Statements

Eliminate the hinge-side opening with the GWF Gap Closer. Designed to run the full length of our standard 4"×4" or 6"×6" gate posts, it seamlessly conceals any clearance required for hinges—ensuring a sleek, uninterrupted look that transforms your gate into a truly "gapless" solution.



- **Sleek Aesthetic:** Creates a clean, modern appearance by covering the hinge gap completely.
- **Engineered Fit:** Purpose-built for GWF Gate systems to ensure perfect integration and consistent styling.
- **Enhanced Privacy:** Minimizes gaps, adding an extra layer of coverage and security.
- **Universal Compatibility:** Works with both 4"×4" and 6"×6" GWF gate posts

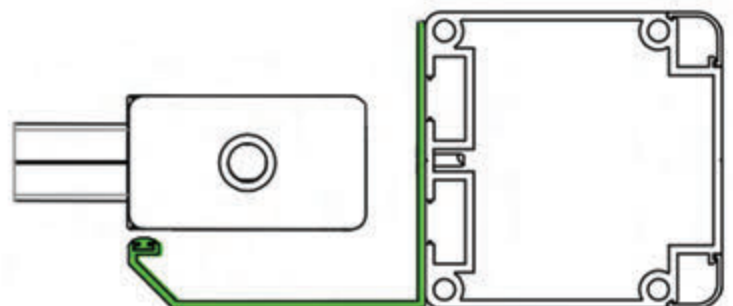

VINYL SERIES

GWF Premium Vinyl Series

Vinyl Fence, Perfected to an Unprecedented Standard of Excellence and Innovation.

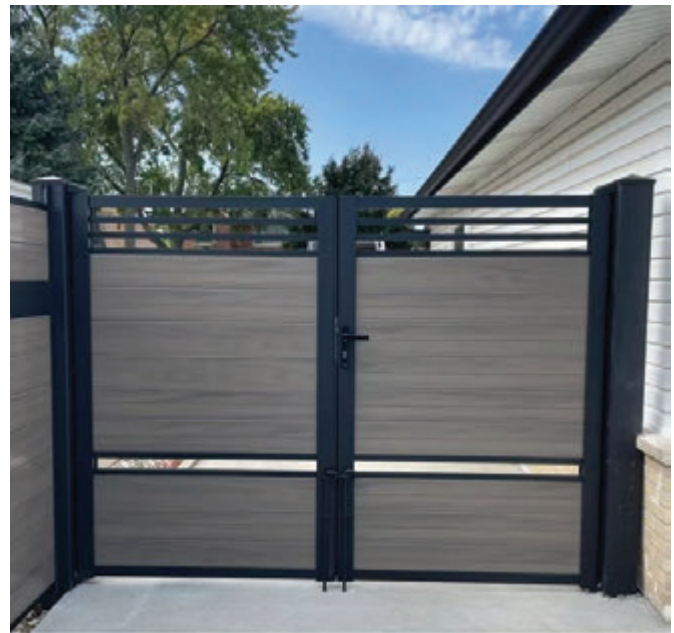

Elevate your property with the GWF Premium Vinyl Fence - designed for lasting beauty, strength, and **low maintenance**. Combining durable vinyl with sleek aluminum framing, this versatile fence offers the perfect balance of aesthetic appeal and weather resistance, making it suitable for both residential and commercial applications.

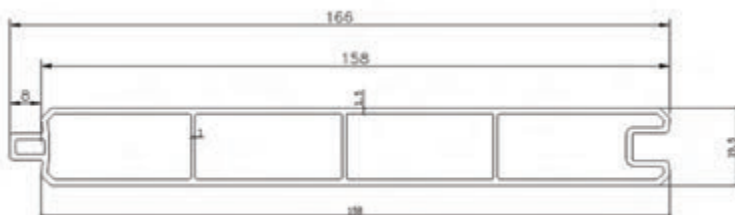

- **Durable & Stylish:** Tongue-and-groove vinyl boards paired with robust aluminum framing for a smooth, continuous look.
- **Cost-Effective:** A high-quality alternative to WPC, offering long-term durability at a competitive price.
- **Versatile Installation:** Easy-to-install, customizable system to suit any height or layout.
- **Premium Grade:** Meets both residential and commercial standards for strength and performance.
- **Sustainable Choice:** Built to last, reducing the need for frequent replacements.

ALUMINUM

GWF Aluminum Euro Slat Fence

Tailored Style & Privacy for the Modern World



- **Customizable Slat Spacing:** Adjust slats to any size for tailored aesthetics and privacy.
- **Durable & Low Maintenance:** Constructed from high-quality 6063 aluminum for long-lasting performance.
- **Seamless Integration:** Compatible with the GWF modular fence system for easy assembly.
- **Modern Design:** Clean lines and a sophisticated finish to complement contemporary landscapes.

Available now at greenwoodfence.com

ALUMINUM EURO FENCE (6 X 6)
(4-1/8" SLATS, 1" SPACING)

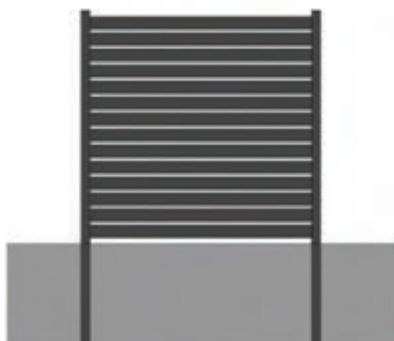

ALUMINUM EURO FENCE (5 X 6)
(4-1/8" SLATS, 2" SPACING)

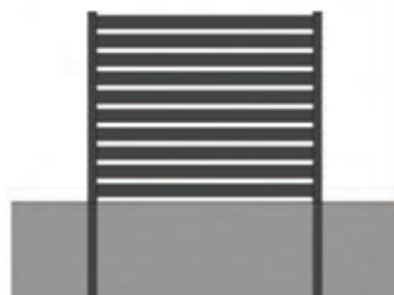



CONTACT US

WWW.GREENWOODFENCE.COM

INFO@GREENWOODFENCE.COM

1-888-24FENCE